

AMERICAN RANGE®

A  Company

Project _____

Item # _____

Quantity _____

24" / 36" RADIANT BROILER WITH OVEN BASE

GAS TYPE: NATURAL LP



AR-2RB

AR-3RB

STANDARD FEATURES

- Commercial gas range available in 24", 36", 48" wide and 32 1/2" depth.
- Cooking height 38".
- Stainless steel sides, front and 6" deep front landing ledge.
- Adjustable steel legs (casters optional).
- 6" stub back is standard on radiant broiler ranges.
- Two year limited warranty, parts and labor.

RADIANT BROILER TOP FEATURES

- Equipped with one 15,000 BTU rated steel burner at every 6" width.
- Heavy duty reversible cast-iron top grates.
- Removable full-width drip pan under burner.
- Removable, heavy duty stainless steel pilots for each burner. One manual gas control valve per burner.

STANDARD 26-1/2" OVEN

- Steel oven burner rated at 35,000 BTU/hr.
- Oven dimensions: 26 1/2"W x 22 1/2"D x 13 1/2"H.
- Thermostat ranging from 250°F to 500°F (121°C to 260°C).
- Oven Door: Spring assisted, counterweight door.
- Two chrome plated oven racks (additional racks optional).
- Two fixed rack positions.
- Porcelain enamel oven interior for easy cleaning.
- 100% safety gas shut off.

CONVECTION OVEN *(In place of standard oven)*

- Steel oven burner rated at 30,000 BTU/hr.
- Oven dimensions: 26 1/2"W x 22 1/2"D x 13 1/2"H.
- Two chrome plated oven racks (additional racks optional).
- Chrome rack guides with five tray positions.
- Convection oven fan improves heat transfer for a faster cook time.
- Thermostat ranging from 250°F to 500°F (121°C to 260°C).

INNOVECTION® OVEN *(In place of standard oven)*

- Steel oven burner rated at 30,000 BTU/hr.
- Oven dimensions: 26 1/2"W x 22 5/8"D x 13 1/2"H.
- Two chrome plated oven racks (additional racks optional).
- Two fixed rack positions.
- Thermostat ranging from 250°F to 500°F (121°C to 260°C).
- The low speed blower motor circulates heat to provide a uniform heating pattern.

STANDARD 20" SPACE SAVER OVEN AR-2RB

- Steel oven burner rated at 27,000 BTU/hr.
- Space Saver Oven dimensions: 20"W x 26 1/2"D x 13 1/2"H.

AVAILABLE OPTIONS

- Swivel Casters (set of four – two with front brakes).
- Storage Cabinet Base. *(In place of standard oven).*



Model Shown AR-4RB-126L-SBR

Shown with optional casters.

DESCRIPTION

American Range, radiant broiler with oven base, (Space Saver Oven 24"), 36", 48" wide. Height of unit is 38"
Stainless steel front, sides, backriser, shelf and 6" adjustable legs. Removable full width drip pan. Equipped with one 15,000 BTU rated steel burner at every 6" width. Heavy-duty reversible cast-iron top grates. Burner knobs are cool to the touch, high temperature material. One oven: 35,000 BTU/hr. standard oven, 30,000 BTU/hr. for convection or innovection with porcelain interior and inside door panel, standard oven interior measures 26-1/2"W x 22-1/2"D x 13-1/2"H and Space Saver oven interior measures 20"W x 26-1/2"D x 13-1/2"H. Space Saver oven is 27,000 BTU/hr. All oven thermostats adjusts from 250°F to 500°F. All ovens supplied with two racks. Oven door with a spring assisted, counterweight mechanism requiring no adjustment. Rear gas connection and pressure regulator.



DESIGNED & BUILT IN USA
PROFESSIONAL COOKING EQUIPMENT

AMERICAN RANGE®

A  Company

13592 Desmond St Pacoima CA 91331
T. 818.897.0808 Toll Free: 888.753.9898
www.AmericanRange.com

RADIANT BROILER WITH OVEN BASE

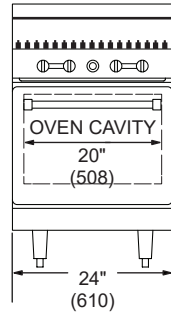

Front AR-2RB with Space Saver Oven

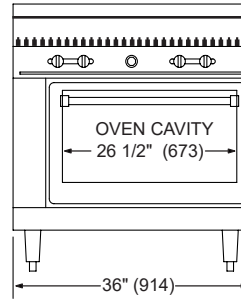

Front AR-3RB with 26-1/2" Oven

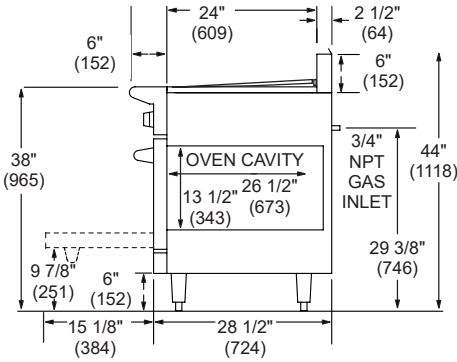

Side AR-2RB and AR-4RB with 20" Oven Base

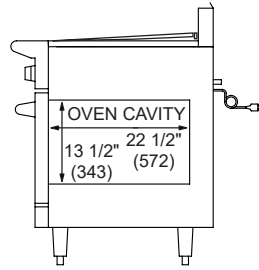

Side Standard with 26-1/2" Oven Base

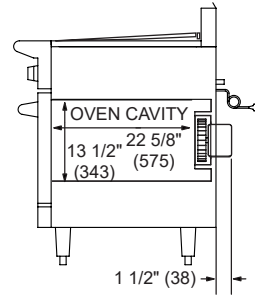

Side Innovation® with 26-1/2" Oven Base

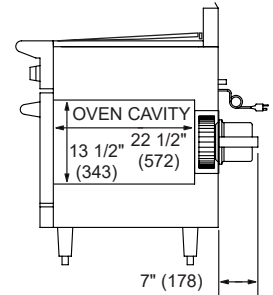

Side Convection with 26-1/2" Oven Base

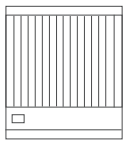

MODEL	TOP	Shipping Weight*			
		BTU	(KW)	LBS	(KG)
AR-2RB	20" Standard Space Saver Oven	87,000	(25)	400	(181)
AR-2RB-SB	Storage Base	60,000	(18)	400	(181)

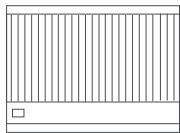

AR-3RB	26 1/2" Standard Oven	125,000	(37)	570	(259)
AR-3RB-SB	Storage Base	90,000	(26)	500	(227)

"C" = Convection Oven, "NV" = Innovation Oven, "SB" = Storage Base, Contact factory for other options.

Specify type of gas and altitude if over 2000 feet.

Please specify gas type when ordering.

NMFCODE: 25970-2 Class: 85

*Shipping weight includes packaging and is approximate.

CONVECTION OVEN ELECTRICAL		
VOLTAGE	PHASE	AMPS
120	1	4

INNOVATION OVEN ELECTRICAL		
VOLTAGE	PHASE	AMPS
120	1	1

MANIFOLD PRESSURE		
NATURAL GAS	PROPANE GAS	MANIFOLD SIZE
5.0" W.C.	10.0" W.C.	3/4" (19MM)

15 amps three prong cord provided

COMBUSTIBLE WALL CLEARANCES:

For use only on non-combustible floors. Legs or casters are required, or 2" (51) overhang is required when curb mounted. Clearance from non-combustible walls is 0". When unit is placed next to combustible walls, clearances must exceed 12" (305) from sides, and 4" (102) from rear. Radiant Broilers for non-combustible locations only.

Commercial cooking equipment requires an adequate ventilation system. For additional information, refer to the National Fire Protection Association's standard.

NFPA96 "Vapor Removal from Cooking Equipment." (NOTE: For North America only)



AMERICAN RANGE®

A **hatco** Company

13592 Desmond St Pacoima CA 91331
T. 818.897.0808 Toll Free: 888.753.9898
www.AmericanRange.com